

P	Cod.	Ø	d	Z	RPM max
15	130 015 02	130	30→50	2	8000
18	130 018 02	130	30→50	2	8000

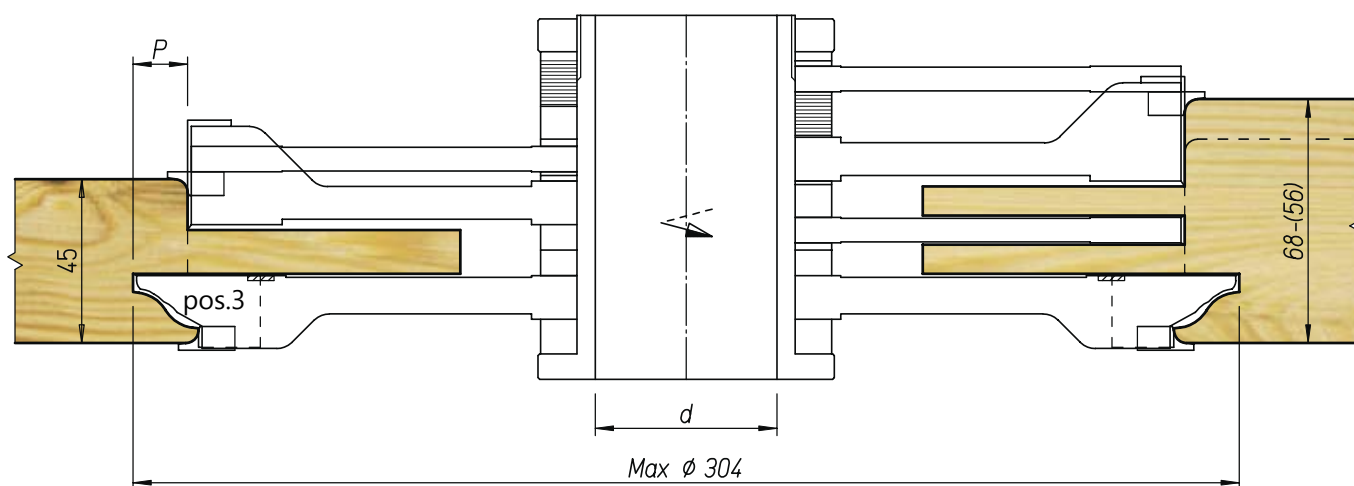

P	Cod.	Ø	d	Z	RPM max
15	304 015 02	304	30→50	2	4400
15	304 015 04	304	30→50	4	4400
18	304 018 02	304	30→50	2	4400
18	304 018 04	304	30→50	4	4400

PROF. "A"

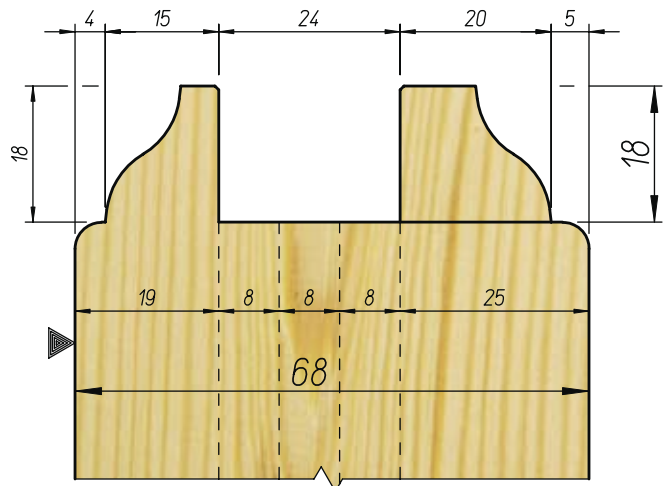
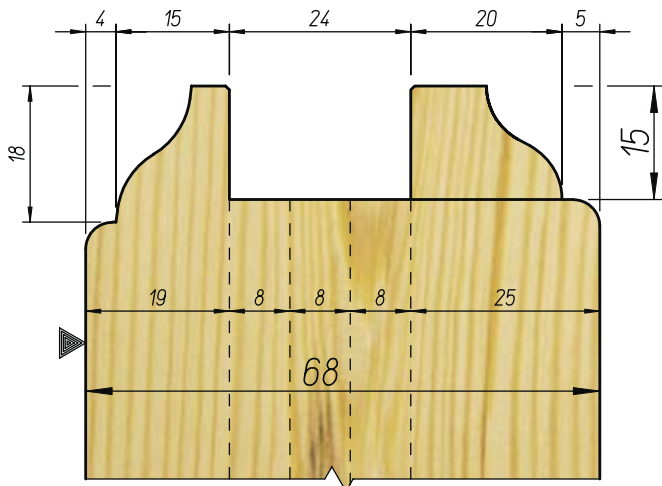
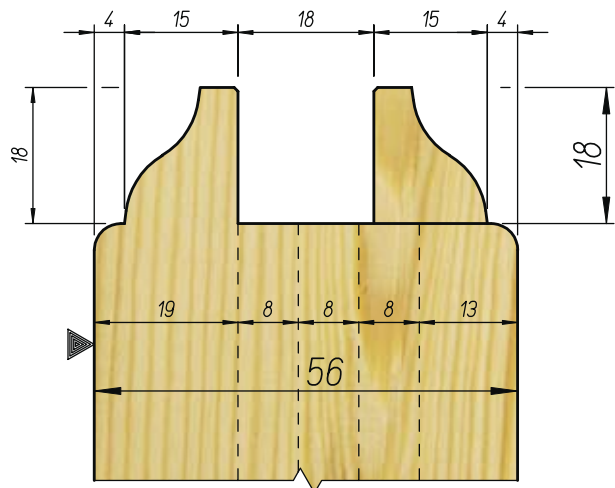
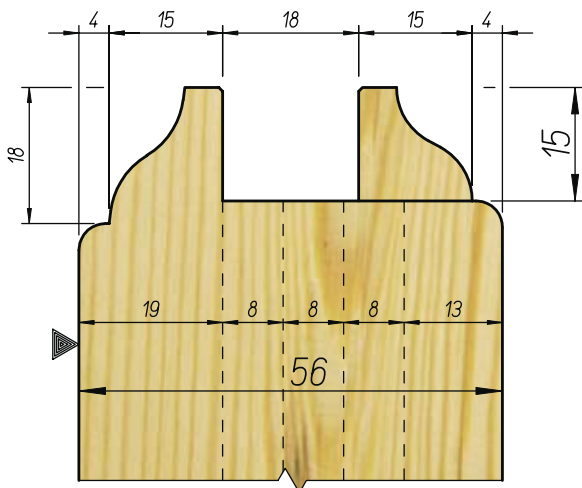
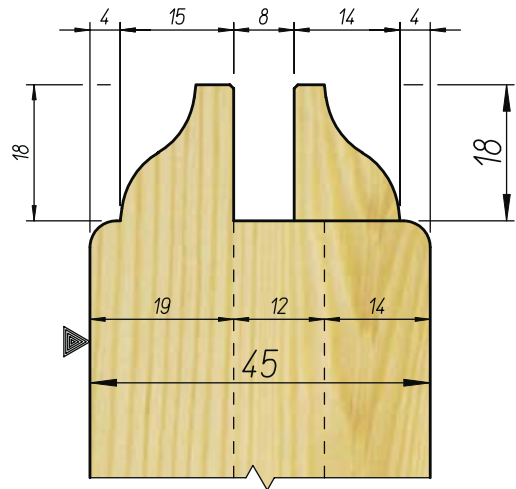
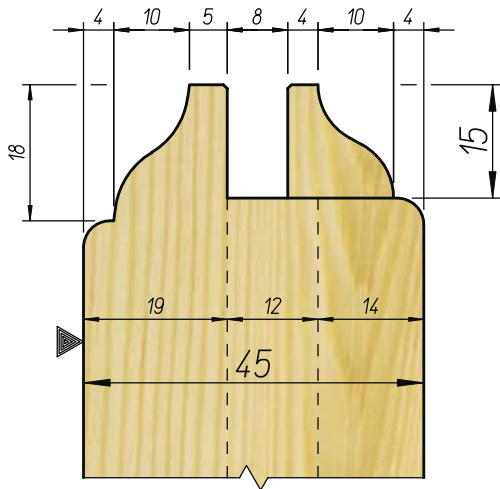

PROF. "B"

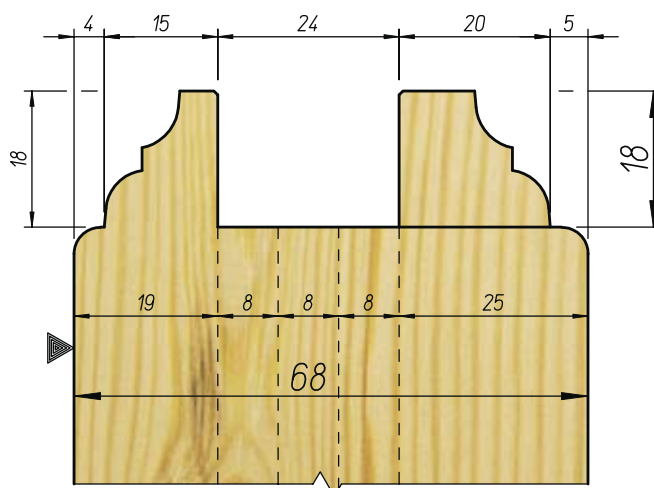
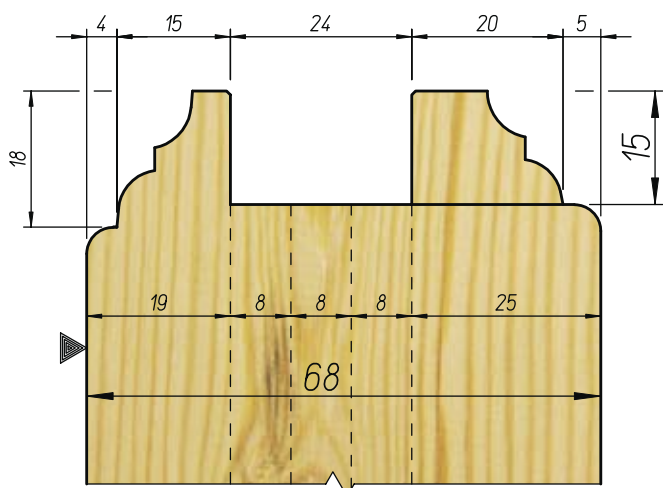
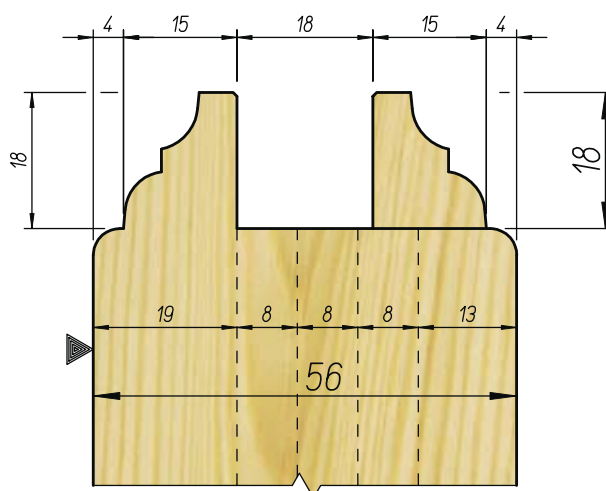
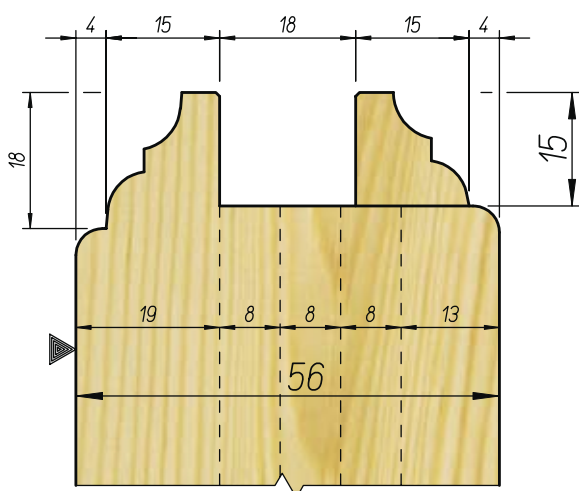
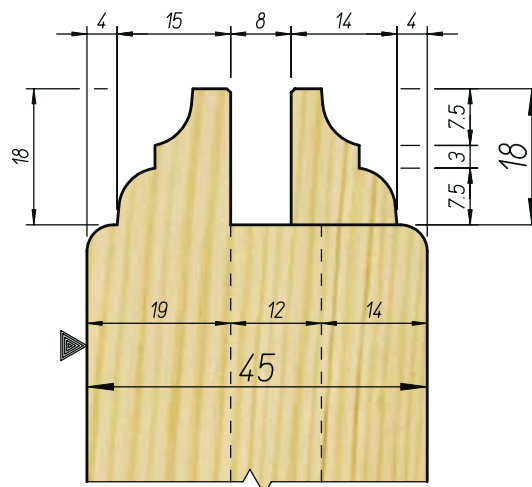
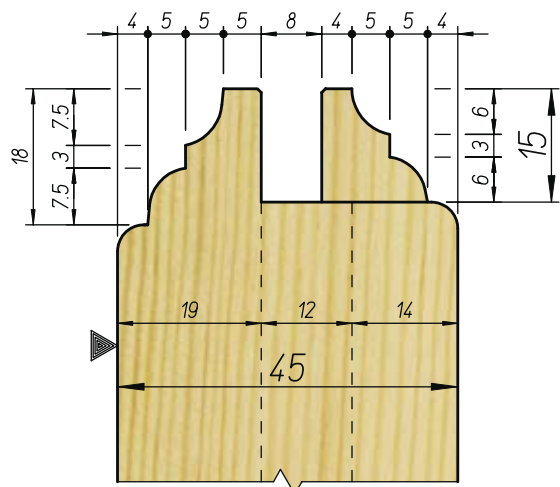

PROF. "C"

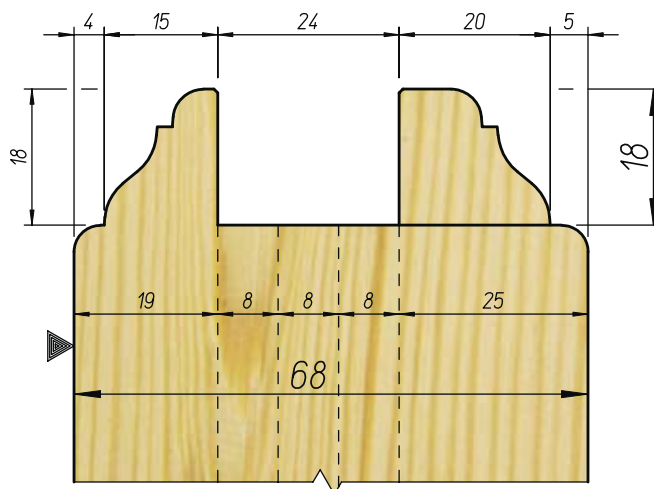
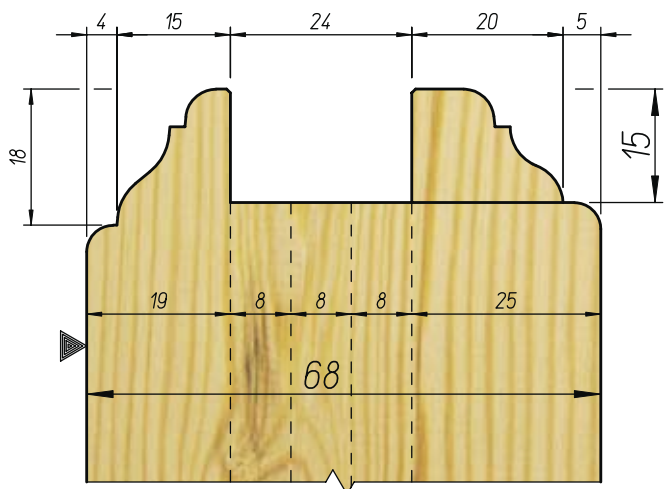
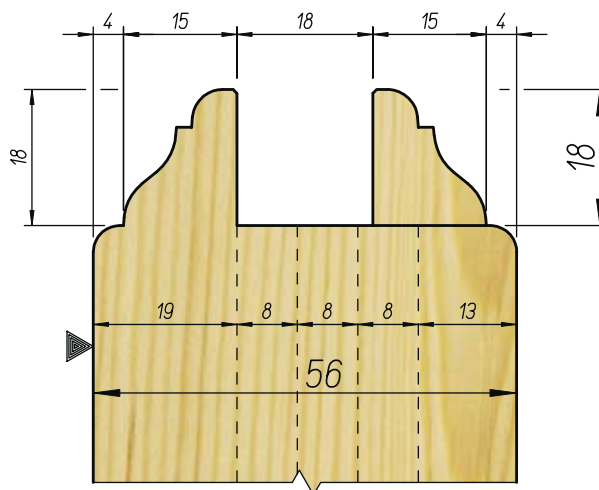
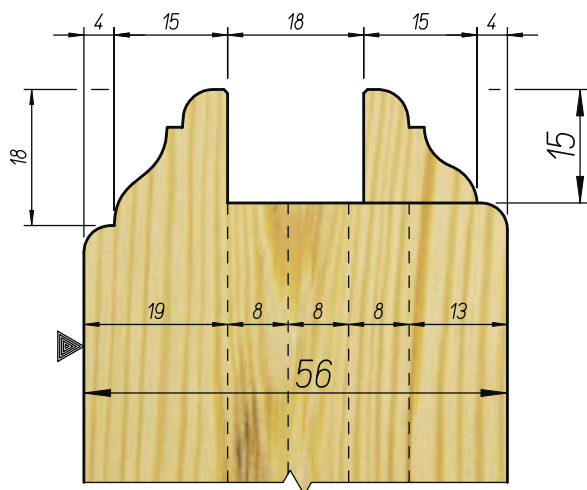
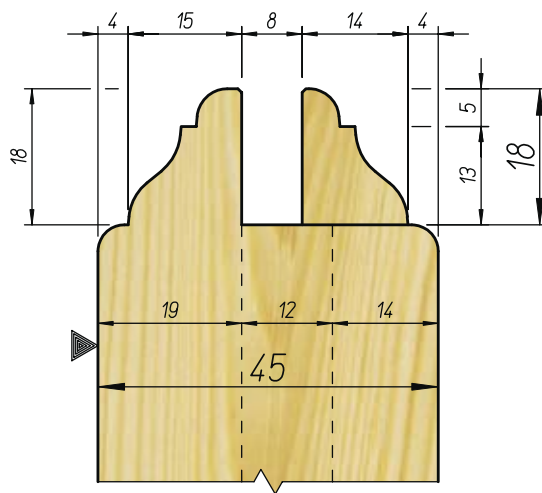
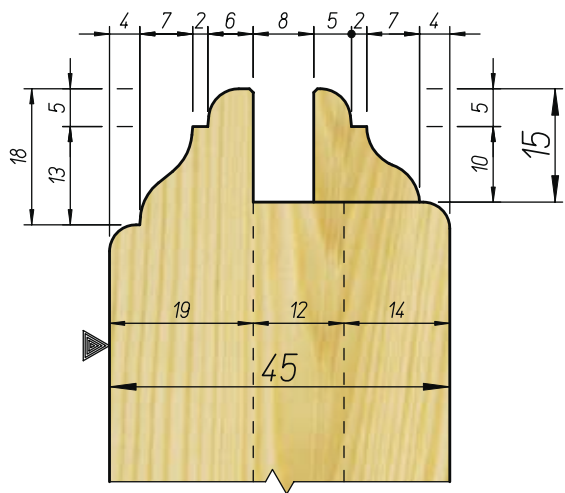

PROF. "D"

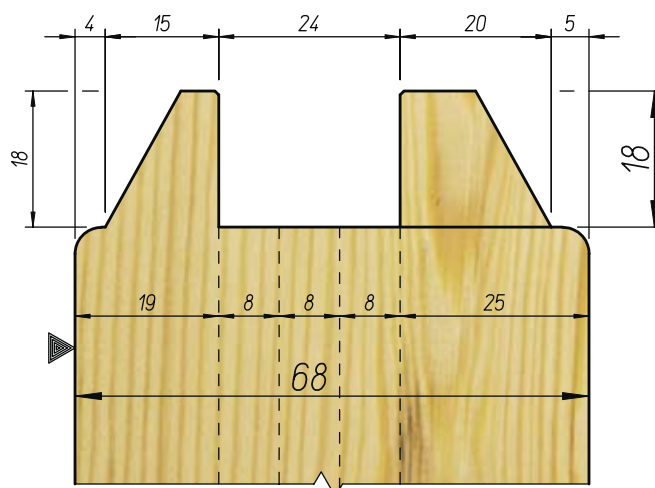
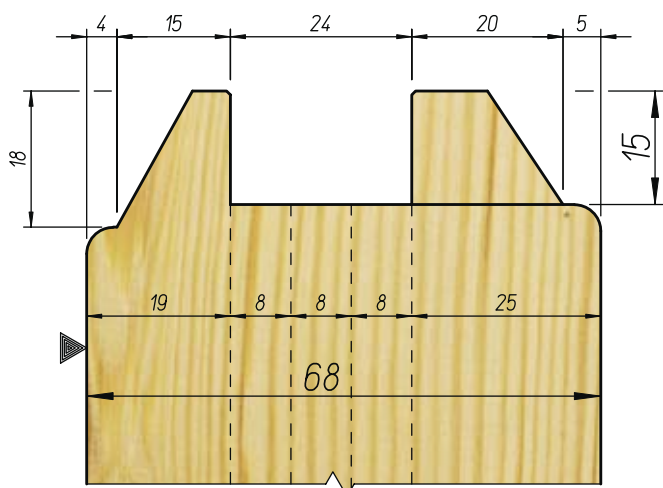
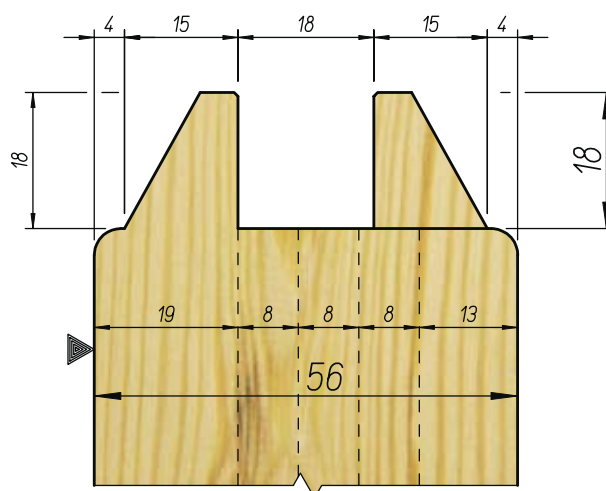
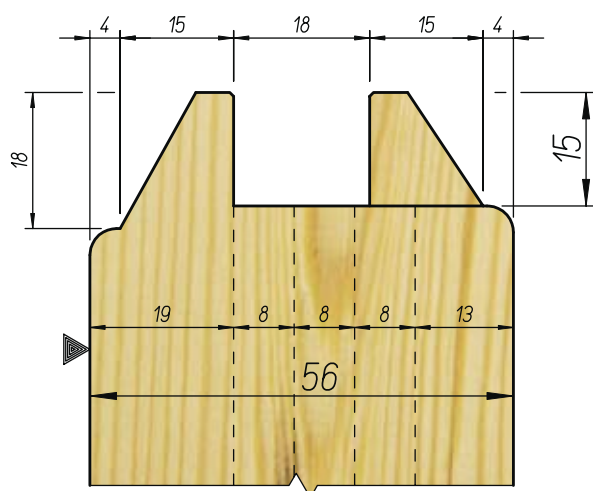
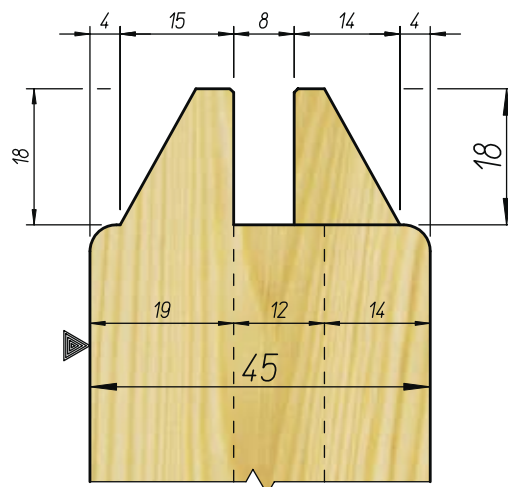
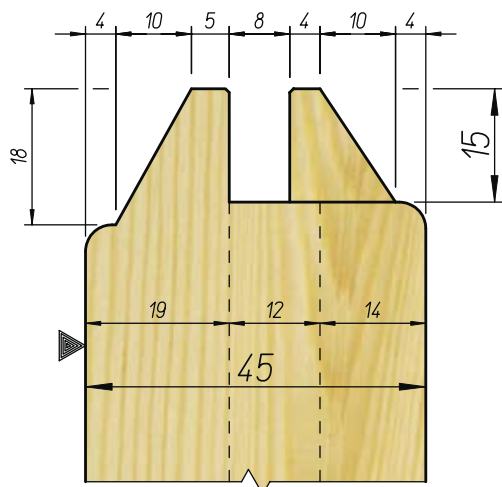

ricambi sagomati profiled knives

Prof. A

Prof. B

Prof. C

Prof. D

Profilo - Profile 15mm

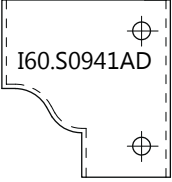
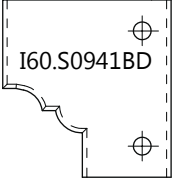
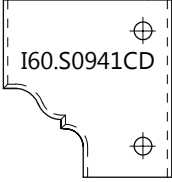
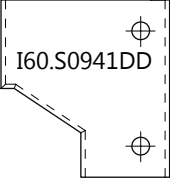
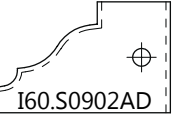
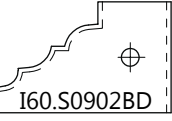
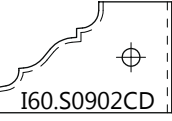
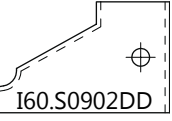
<p>pos.1</p>  <p>I60.S0941AD</p>	<p>pos.1</p>  <p>I60.S0941BD</p>	<p>pos.1</p>  <p>I60.S0941CD</p>	<p>pos.1</p>  <p>I60.S0941DD</p>
 <p>I60.S0902AD</p> <p>pos.2</p>	 <p>I60.S0902BD</p> <p>pos.2</p>	 <p>I60.S0902CD</p> <p>pos.2</p>	 <p>I60.S0902DD</p> <p>pos.2</p>

Profilo - Profile 18mm

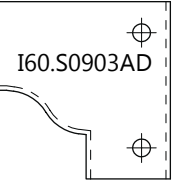
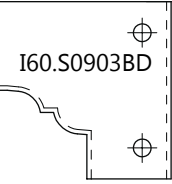
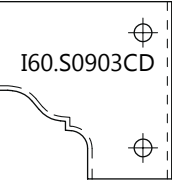
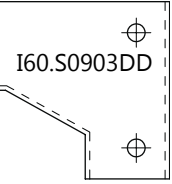
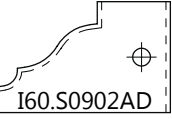
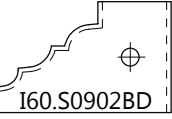
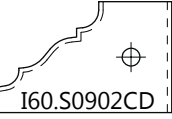
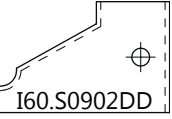
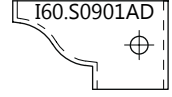
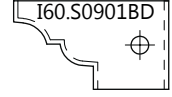
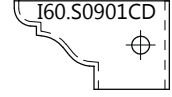
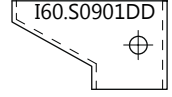
<p>pos.1</p>  <p>I60.S0903AD</p>	<p>pos.1</p>  <p>I60.S0903BD</p>	<p>pos.1</p>  <p>I60.S0903CD</p>	<p>pos.1</p>  <p>I60.S0903DD</p>
 <p>I60.S0902AD</p> <p>pos.2</p>	 <p>I60.S0902BD</p> <p>pos.2</p>	 <p>I60.S0902CD</p> <p>pos.2</p>	 <p>I60.S0902DD</p> <p>pos.2</p>
<p>pos.3</p>  <p>I60.S0901AD</p>	<p>pos.3</p>  <p>I60.S0901BD</p>	<p>pos.3</p>  <p>I60.S0901CD</p>	<p>pos.3</p>  <p>I60.S0901DD</p>

Controprofilo Counterprofile

Nota:

Gli utensili vengono forniti con 1 profilo a scelta tra i 4 disponibili, completi dei distanziali e di tutti gli elementi per realizzare gli spessori indicati.

Tools are supplied with 1 profile to choose from 4 profiles available, complete with spacers and all elements to produce all dimensions indicated.