







# Art. 10 03

-  **ELEMENTI COMPONIBILI PER ANTINE**
-  **COMBINED MULTIPURPOSE PROFILE/COUNTERPROFILES**
-  **GROUPE D'OUTILS MULTIPROFIL POUR PORTE DE CUISINE**

- PROFIL-UND KONTERPROFILWERKZEUGSATZ** 
- ELEMENTOS COMPONIBLES PARA PUERTAS DE COCINA** 
- ФРЕЗА КОМБИНИРОВАННАЯ ПРОФИЛЬ/КОНТРОПРОФИЛЬ** 

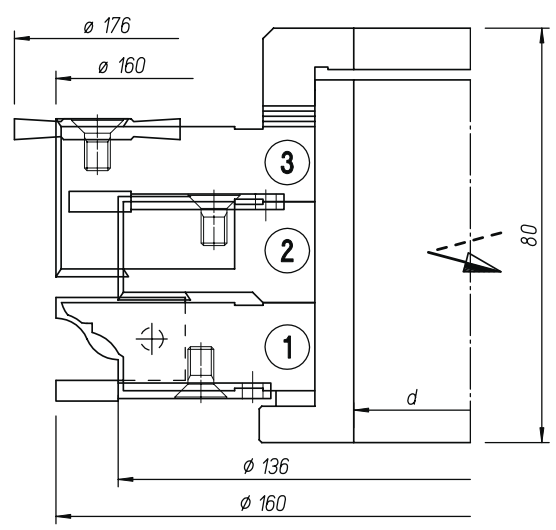

Cod.	d	Z	RPM max
000 000 01	30→50	2	7100

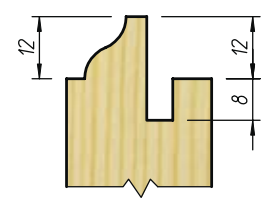
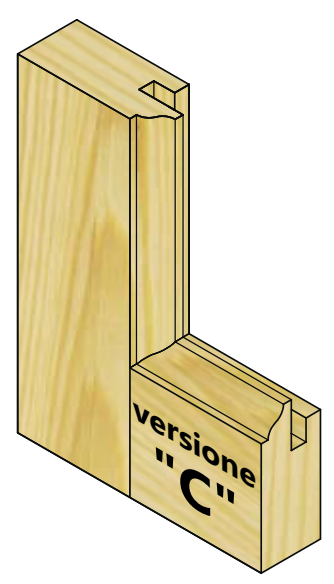
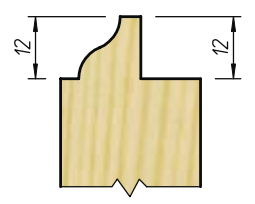
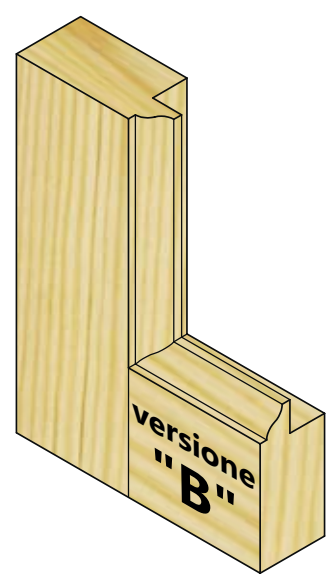
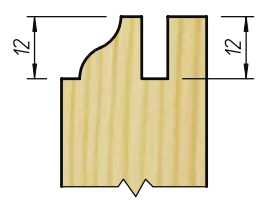
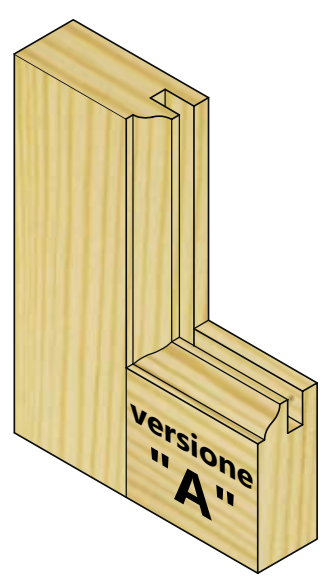

**VIVALDI**

L'utensile realizza tutte le soluzioni rappresentate.  
Tool realises all solutions indicated.

# Versione "A"

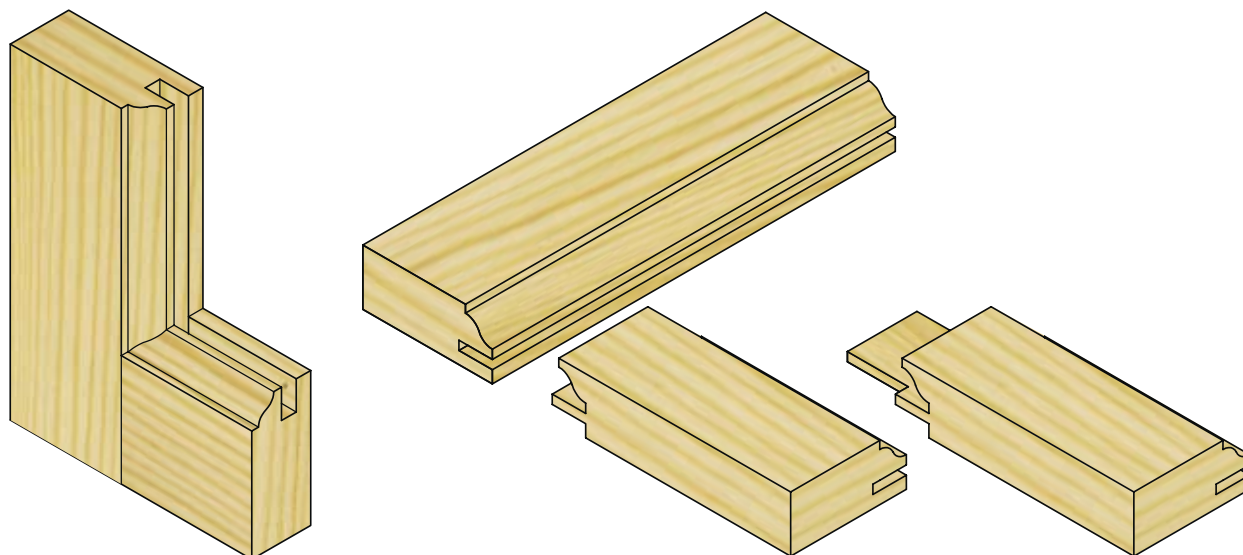

## Profilatura Profile

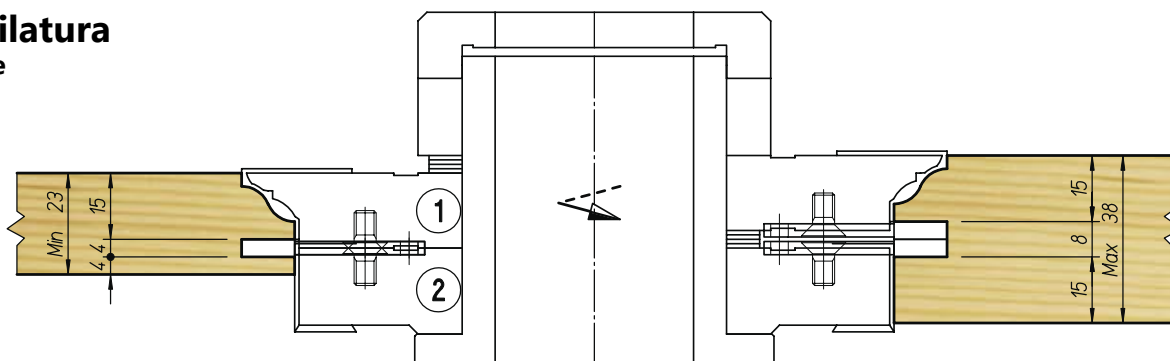

## Controprofilatura Counterprofile

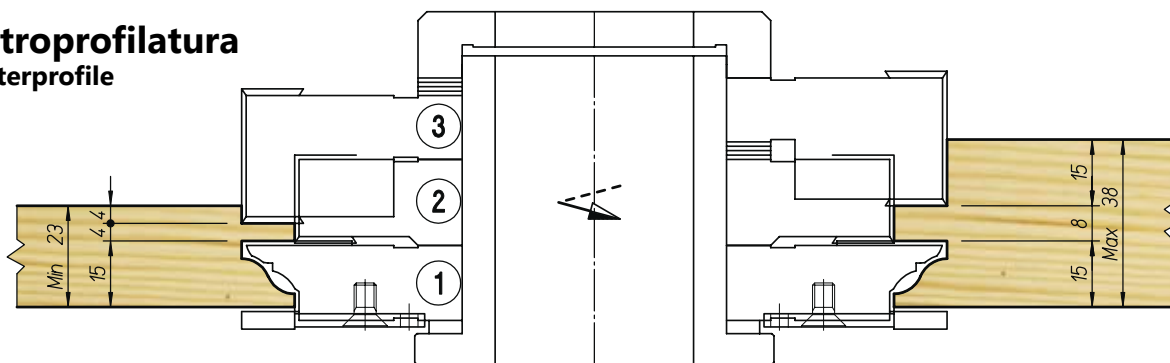

## Tenonatura Tenoning

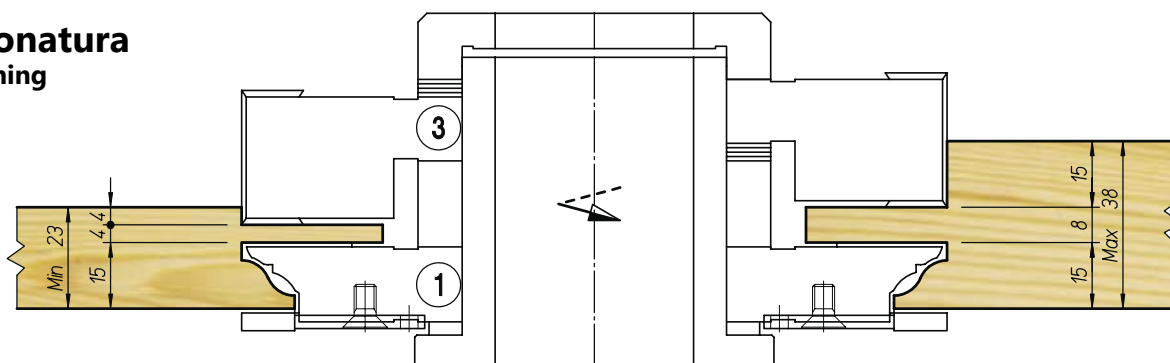

# Versione "B"

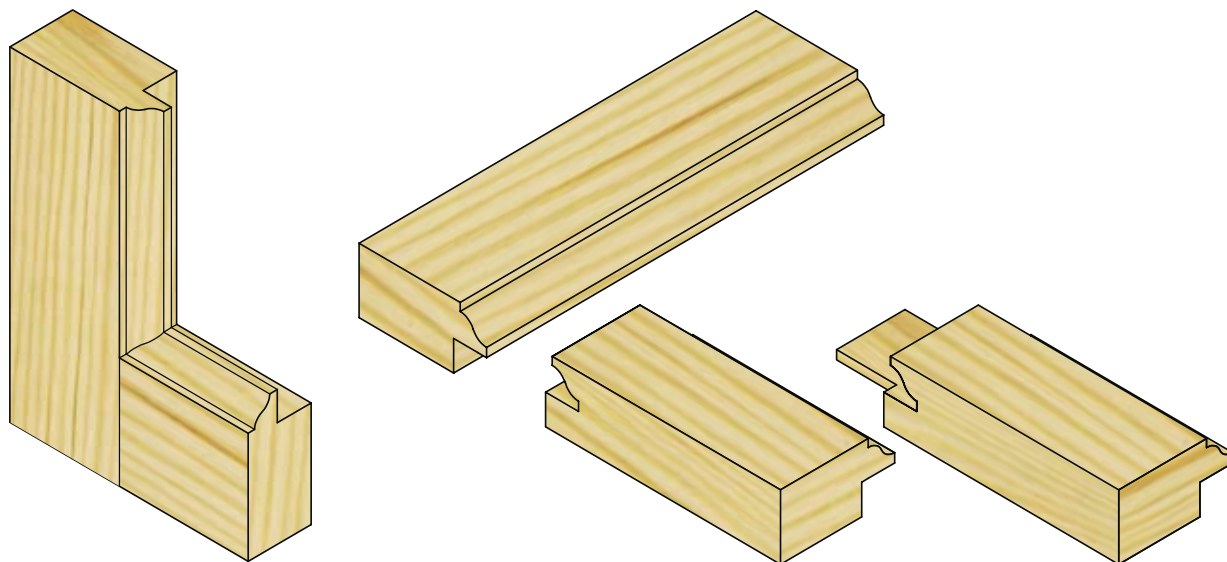

## Profilatura Profile

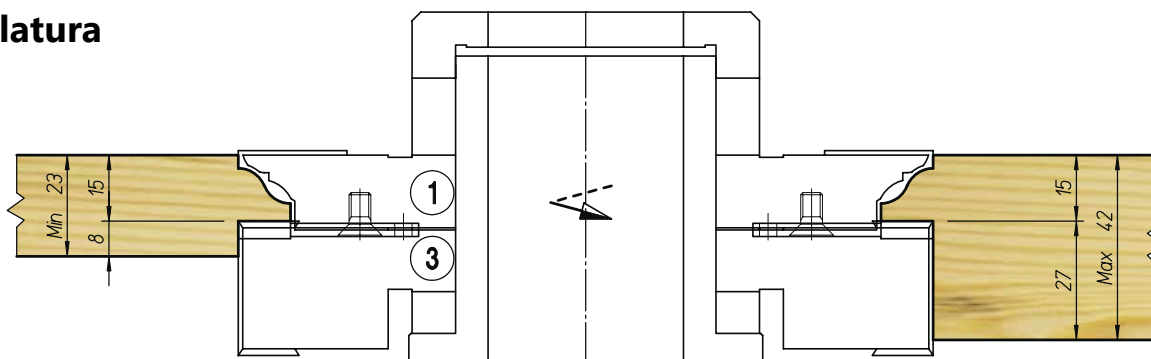

## Controprofilatura Counterprofile

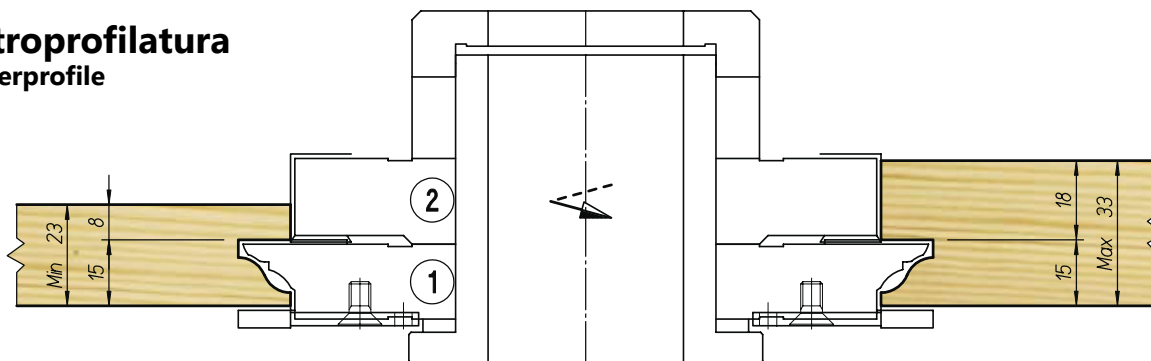

## Tenonatura Tenoning

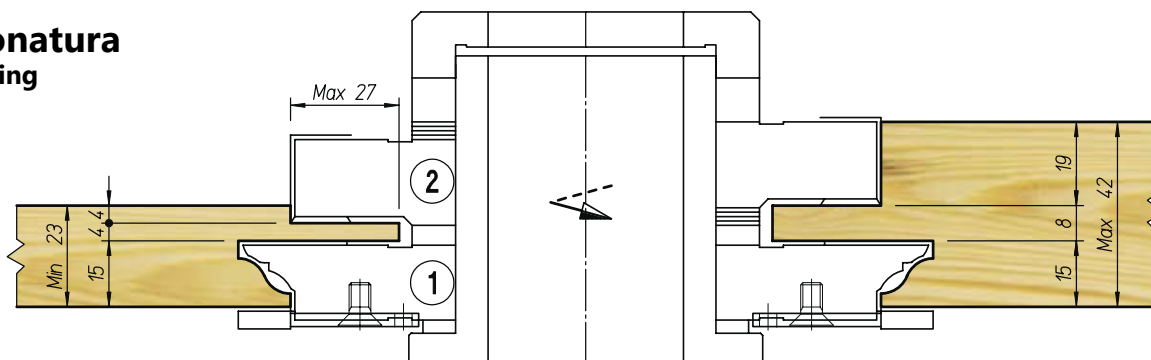

# Versione "C"

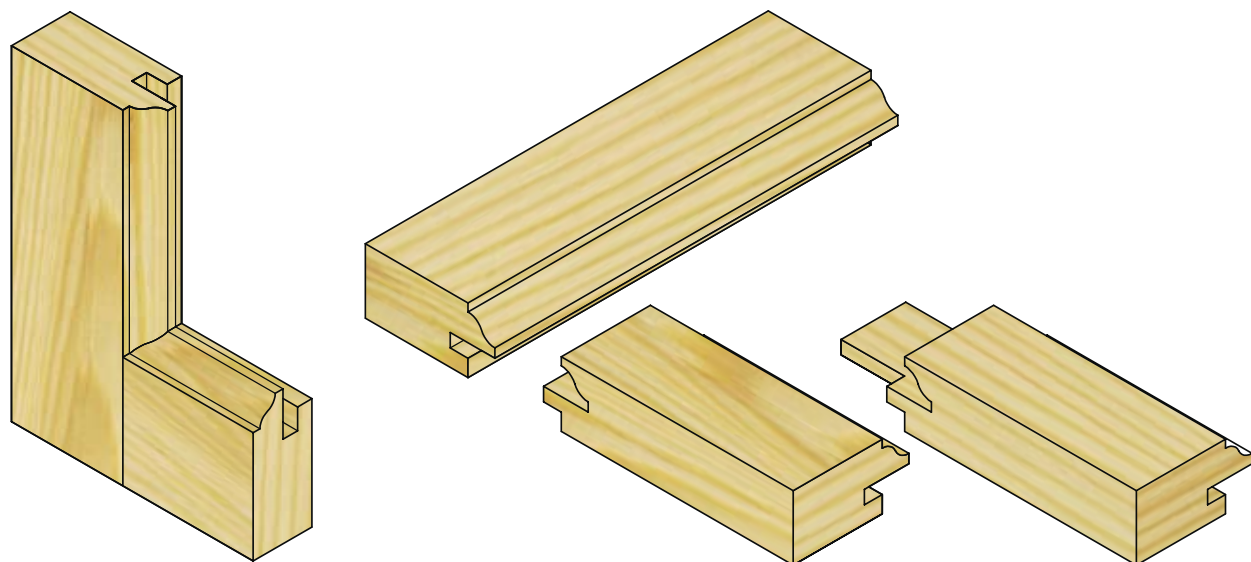

## Profilatura Profile

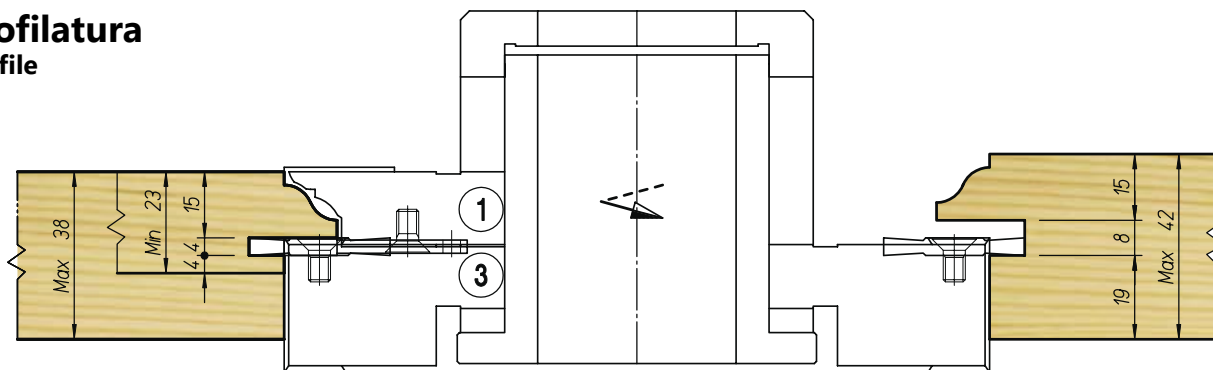

## Controprofilatura Counterprofile

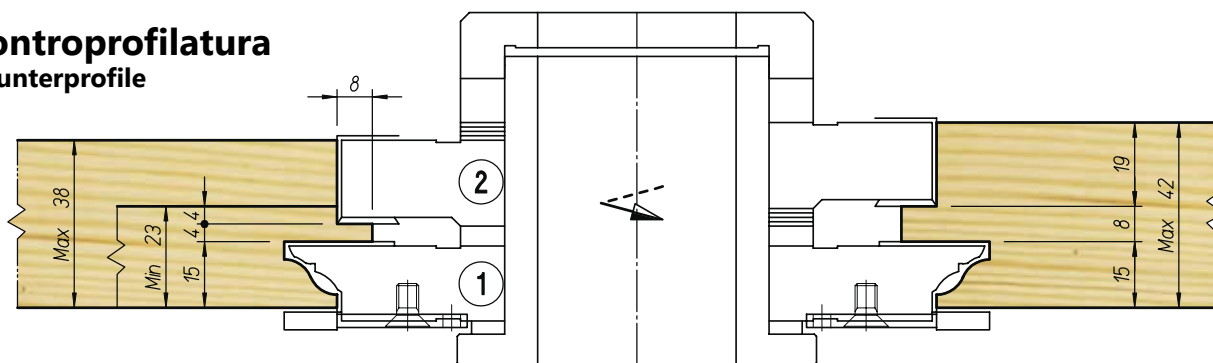

## Tenonatura Tenoning

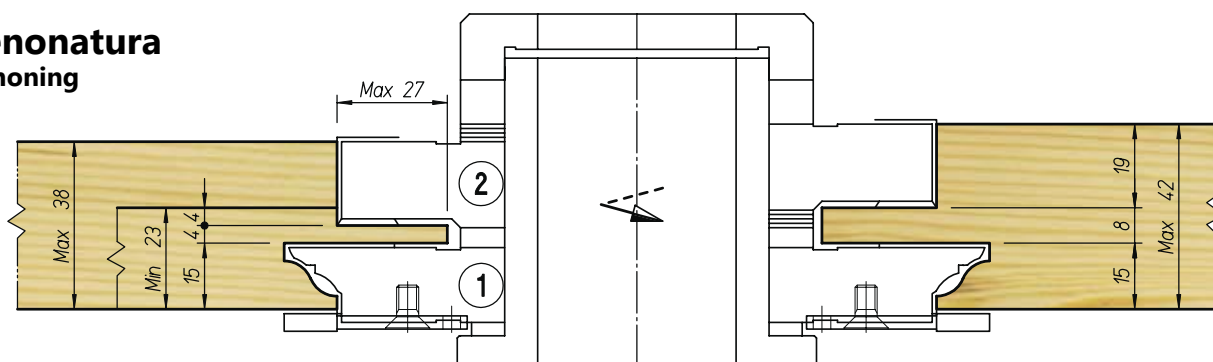

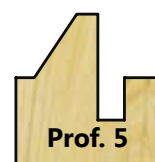
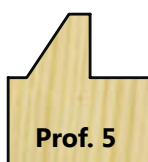
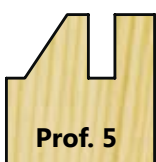
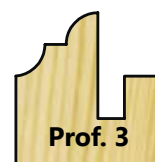
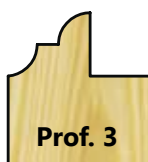
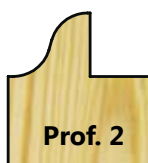
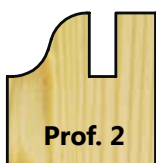
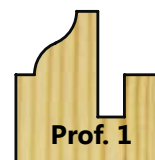
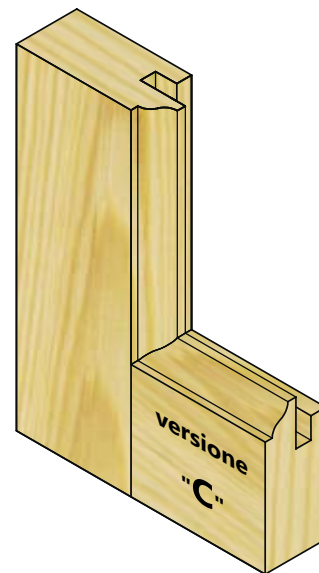
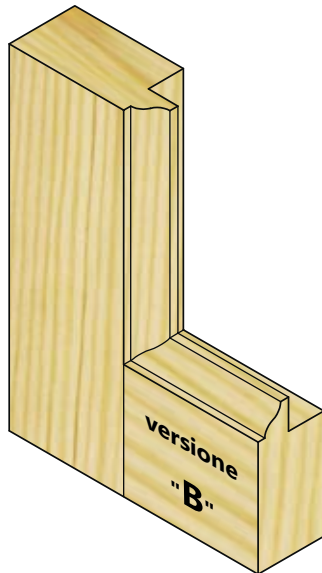
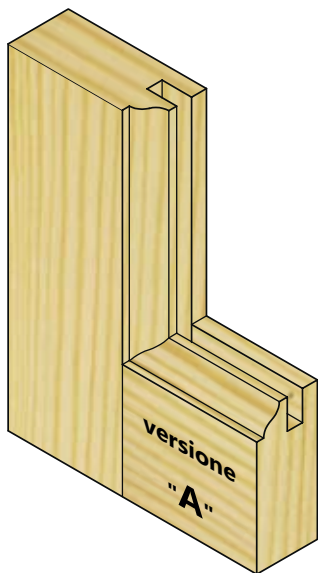

**Prof. 1**

**Prof. 2**

**Prof. 3**

**Prof. 4**

**Prof. 5**

