

Art. 06 04

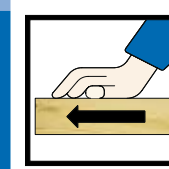

- FRESA
"TRIPLO RAGGIO"**
- TRIPLE-RADIUS
CUTTER HEADS**
- PORTE-OUTILS
TRIPLE RAYONS**
- DREIFACHRADIUS
MESSERKOPF**
- FRESA
"TRIPLE RADIO"**
- ФРЕЗА КОМБИНИРОВАННАЯ
ТРЕХРАДИУСНАЯ**

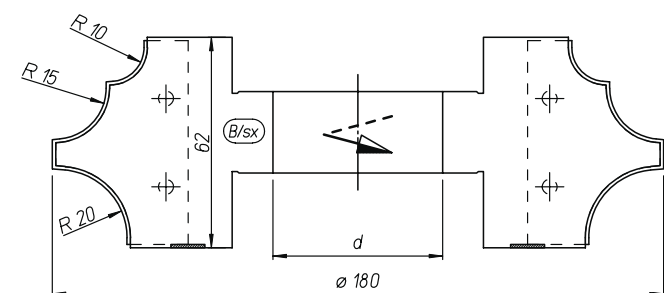
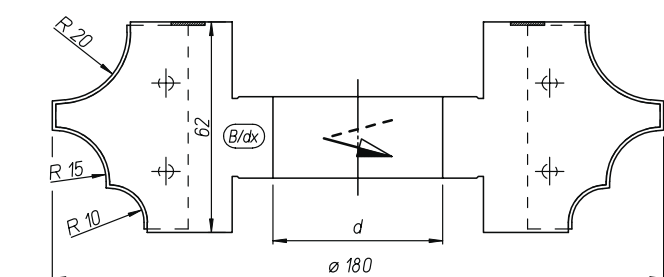
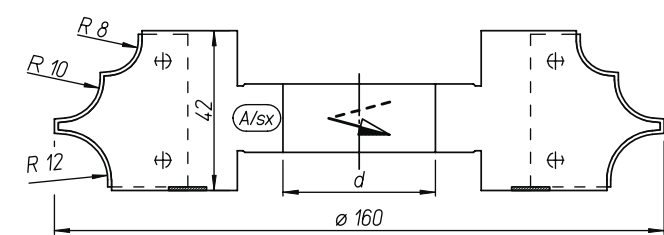
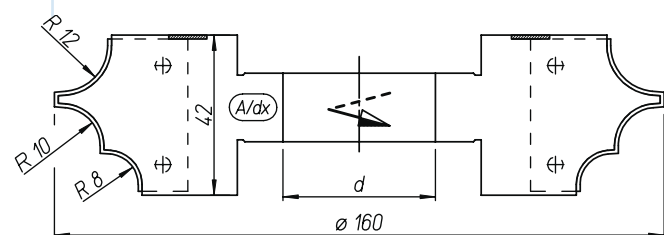
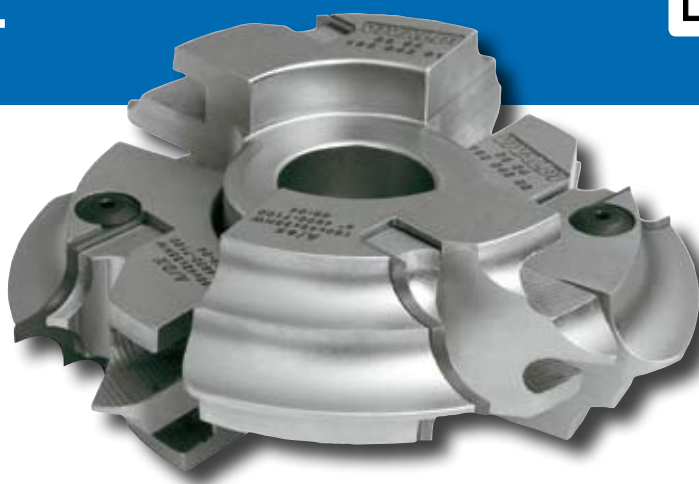

Versione R 8-10-12mm

Cod.	D	R	d	Z	RPM max
160 000 00	160	8-10-12	30→40	2	7100

Ricambi-Spare Parts

Descrizione-Description	Dimensione-Dimension	Codice-Code
Coltello-Knife	R 8-10-12 Dx (el. A/Dx)	I60S9834D
	R 8-10-12 Dx (el. A/Sx)	I60S9834S
Tassello-Wedge	R 8-10-12 Dx (el. A/Dx)	I60S9834D/T
	R 8-10-12 Dx (el. A/Sx)	I60S9834S/T
Vite-Screw	M8x16	V21.8/16CEPC
Fermo-Allen H.	M6x14	V18.6/14

Versione R 10-15-20mm

Cod.	D	R	d	Z	RPM max
180 000 00	180	10-15-20	30→50	2	6600

Ricambi-Spare Parts

Descrizione-Description	Dimensione-Dimension	Codice-Code
Coltello-Knife	R 10-15-20 (el. B/Dx)	I60S9835D
	R 10-15-20 (el. B/Sx)	I60S9835S
Tassello-Wedge	R 10-15-20 (el. B/Dx)	I60S9835D/T
	R 10-15-20 (el. B/Sx)	I60S9835 S/T
Vite-Screw	M8x16	V21.8/16CEPC
Fermo-Allen H.	M6x14	V18.6/14



Versione R 8-10-12mm

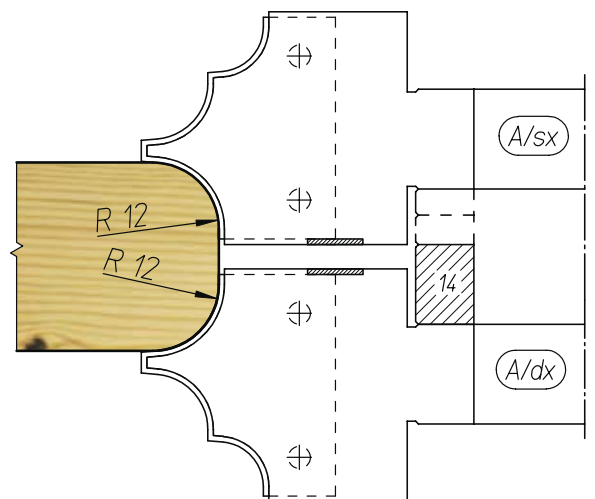
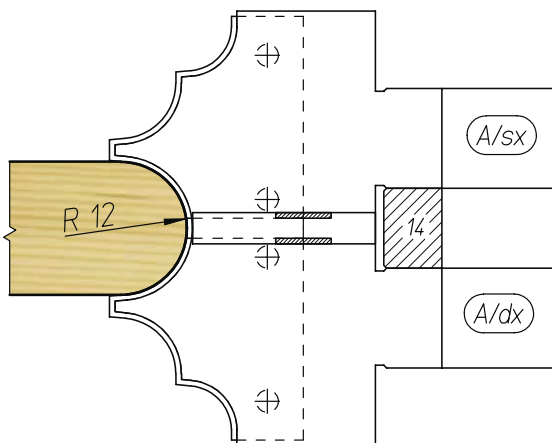
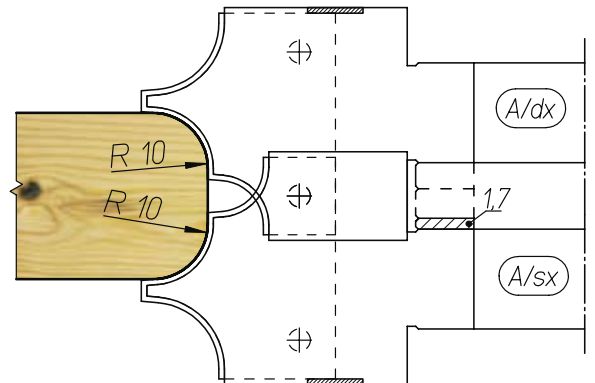
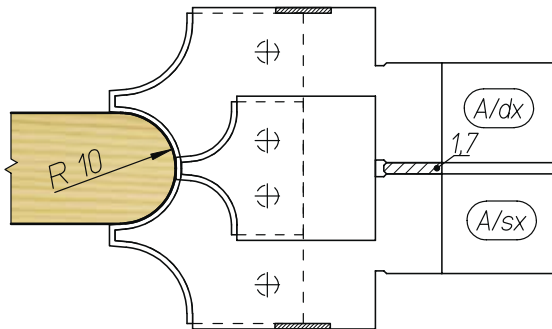
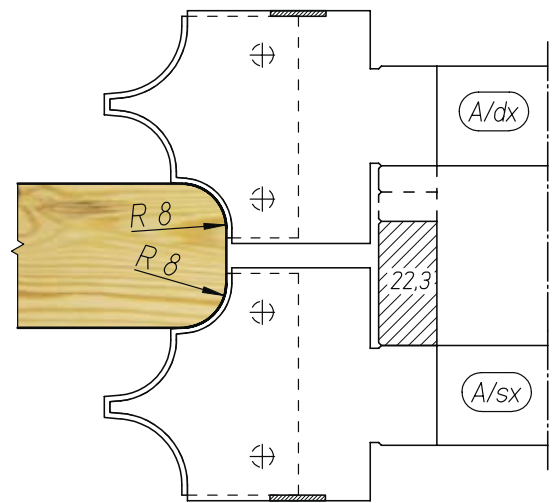
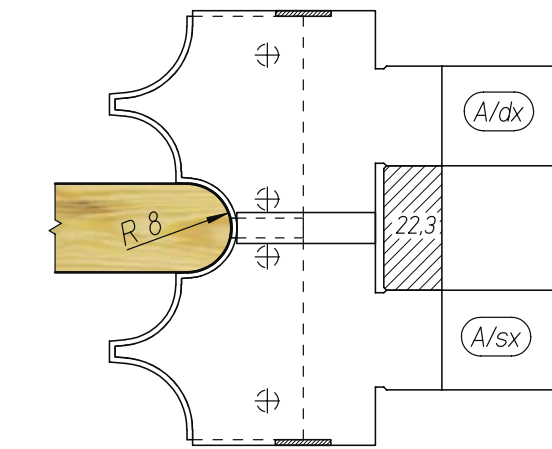

Versione R 10-15-20mm

