

PORTONCINO SAGOMATO

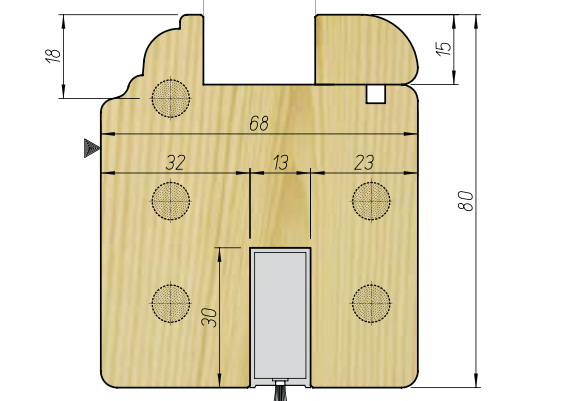

Lavorazioni

Profilatura battente (1 ^ fase)
per portoncini CURVI

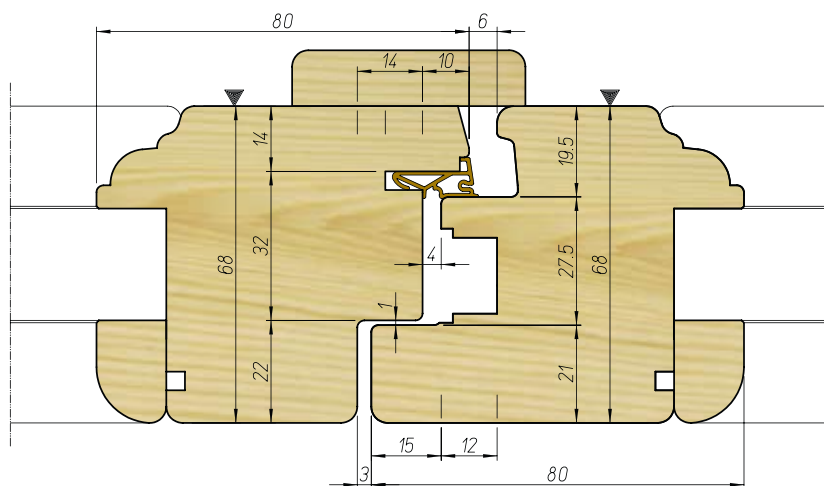
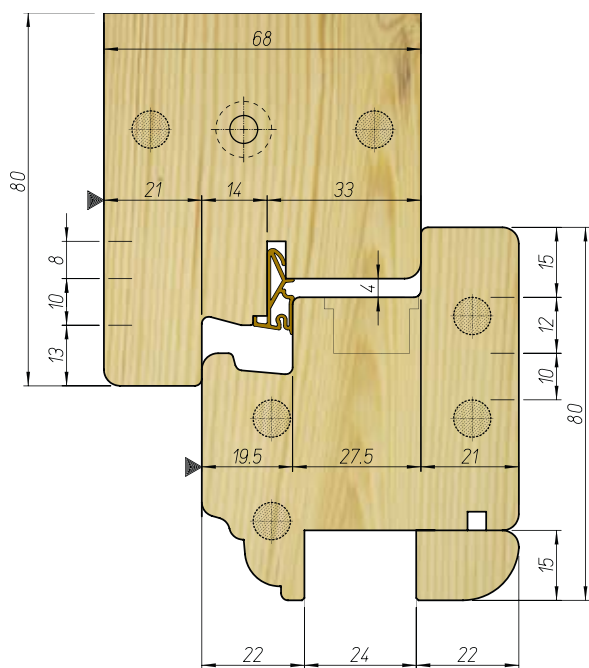
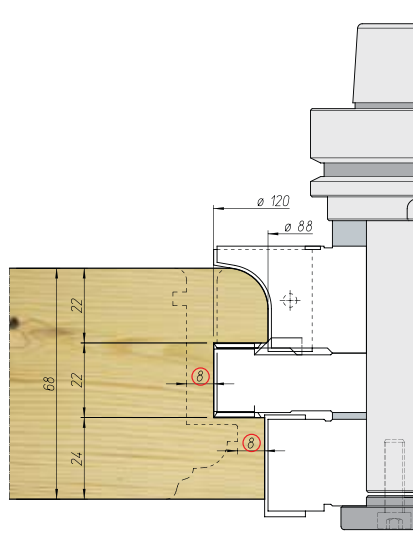

Codice

PN.01

Profilatura battente (1 ^ fase)
per portoncini DIRITTI

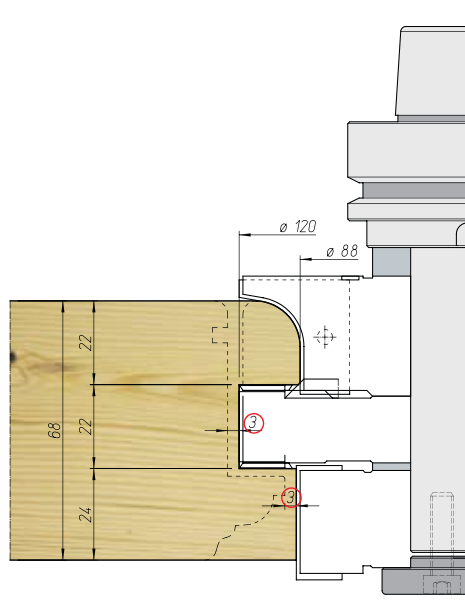

Codice

PN.01b

Attenzione:
forniti senza portautensile

Lavorazioni

Fuga listello

per altre fughe vedi coltelli pag. 56



Codice Colt.
I60S7753D

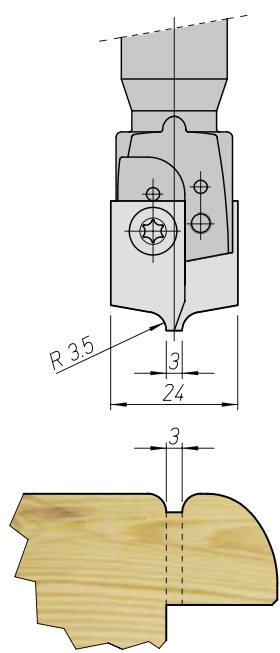

Codice Colt.
I60S7026D

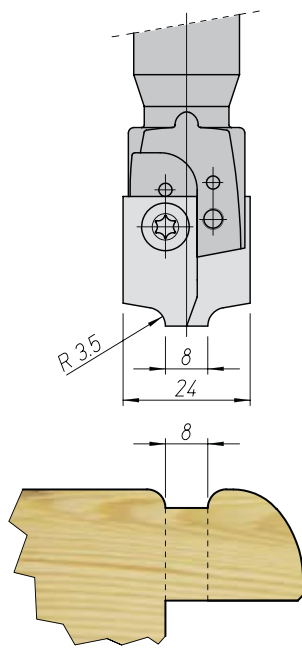

Codice
PN.02

Recupero Listello per serramenti CURVI



Codice uten.
FREL0268
FREL0340

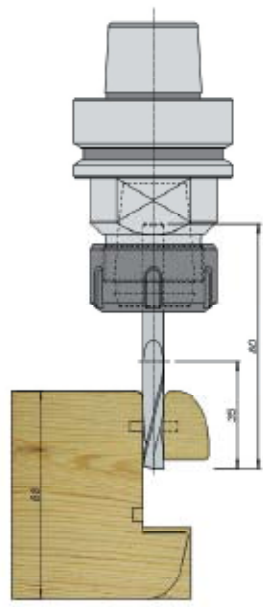

Codice
PN.03a

Attenzione:
forniti senza portautensile

Lavorazioni

Recupero Listello DIRITTI

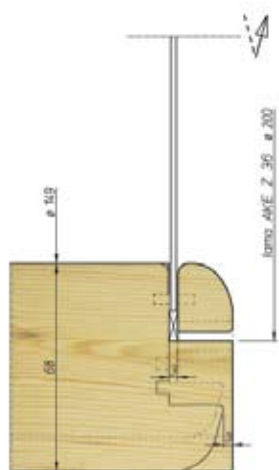

Codice

PN.03b

Profilatura battente (2° fase)

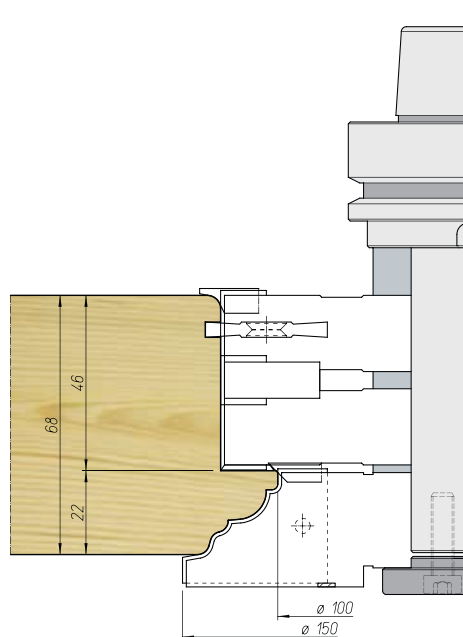

Codice

PN.04

Attenzione:
forniti senza portautensile

Lavorazioni

Intestatura battente

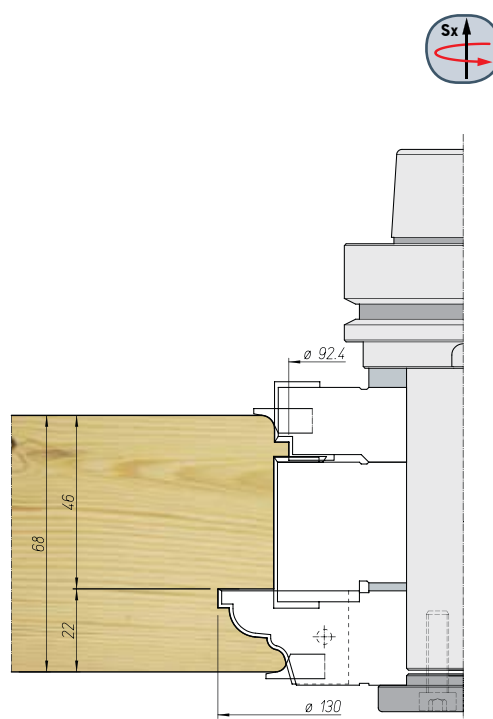
**Codice**

PN.05

Profilatura telaio

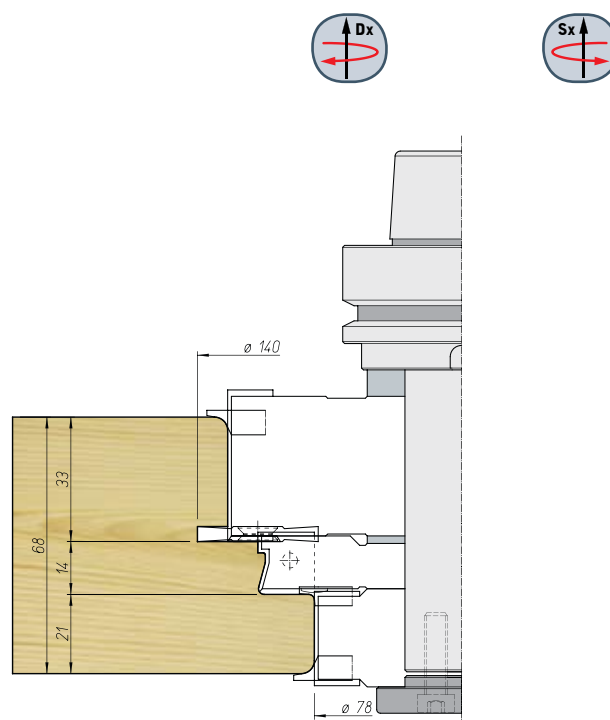
**Codice**

PN.06D

PN.06S

Attenzione:
forniti senza portautensile

VIVALDI

Lavorazioni

Controprofilatura telaio

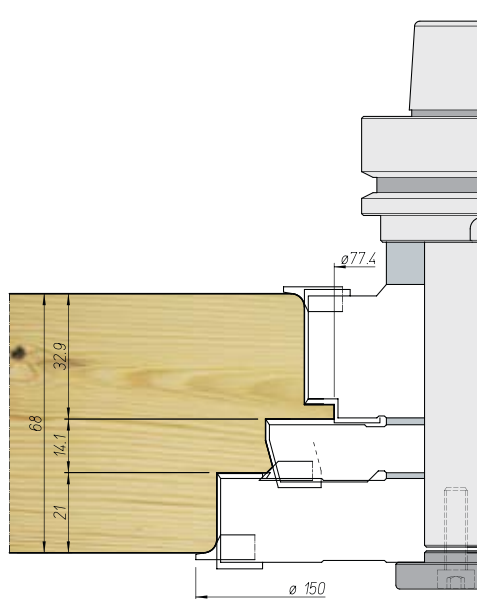

Codice

PN.07

Squadratura battente

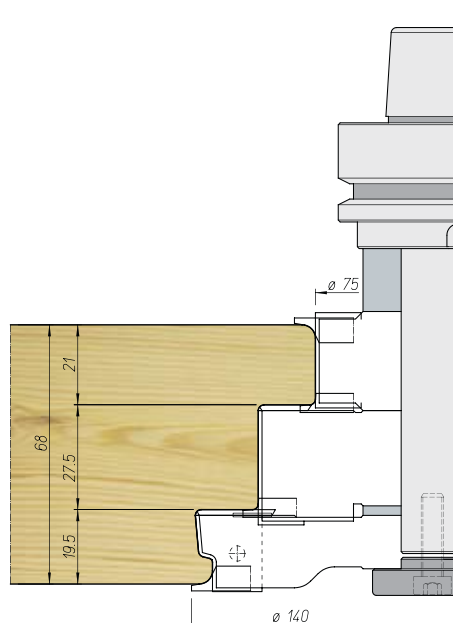

Codice

LA.08

Lavorazioni

Squadratura montante Sx

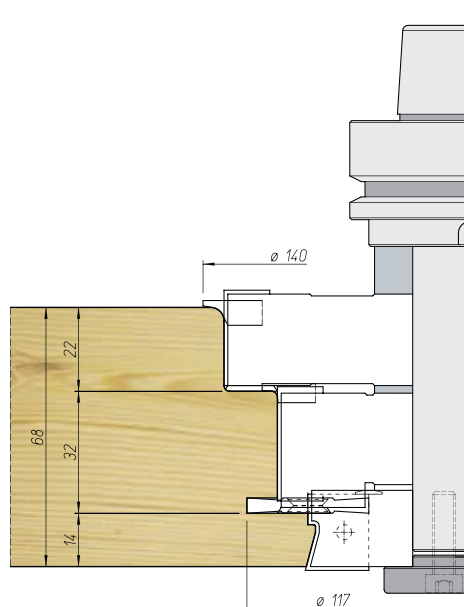

Codice

PN.09

Ripasso sede parafreddo

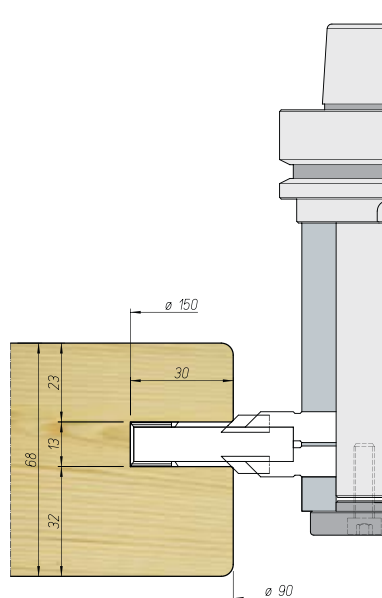

Codice

PN.10

Attenzione:
forniti senza portautensile