

Gruppi per ALZANTE SCORREVOLE PREFINITO

(unione con spine)

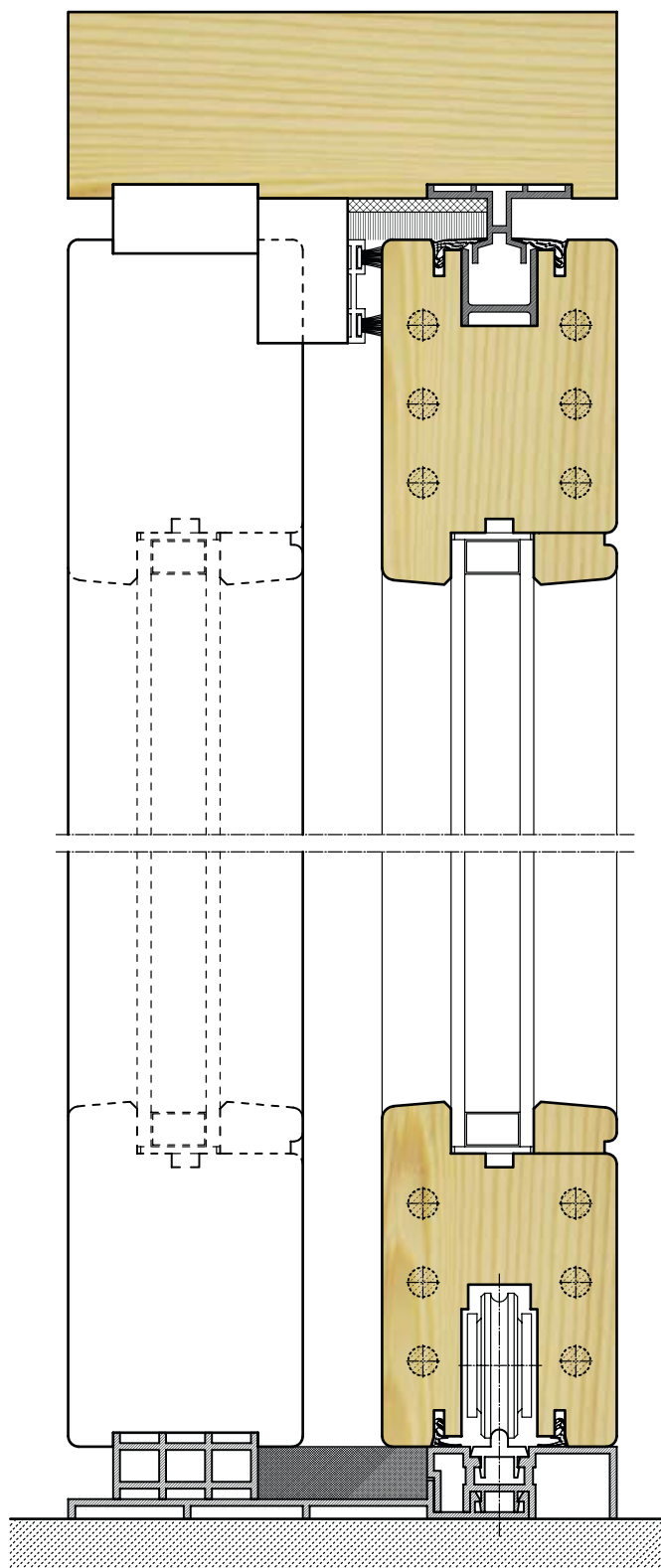
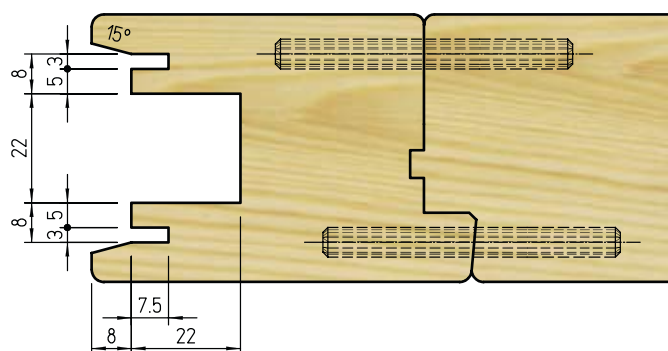
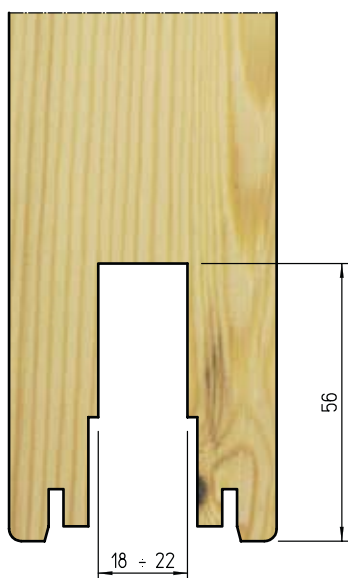
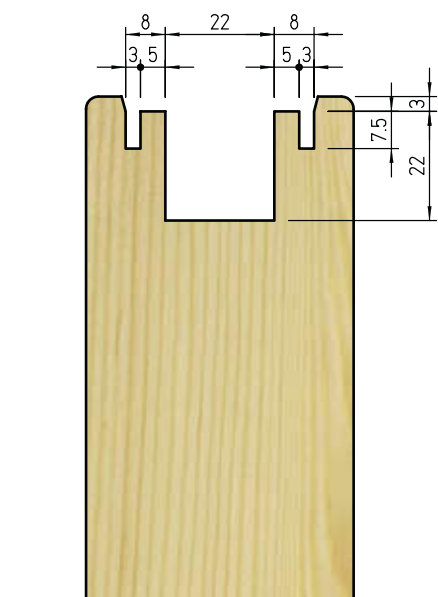

Attenzione:
forniti senza portautensile

Versione Ridotta

Profilatura diritta

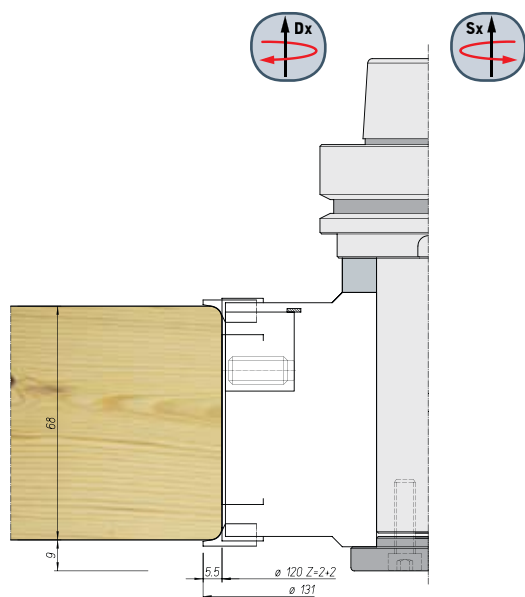

Codice

AS.01D

AS.01S

Squadratura anta fissa + Profilatura telaio

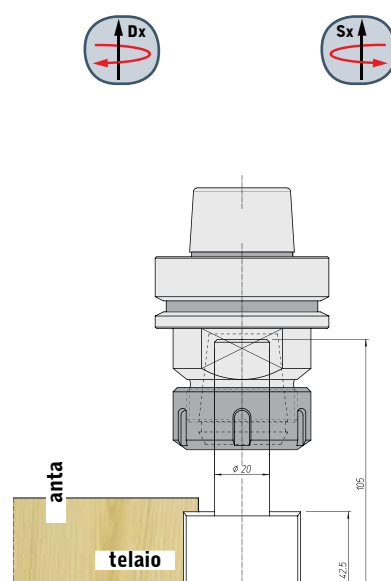

Codice

AS.02D

AS.02s

3mm: sq. montante anta mobile 8mm: sq. trasversi anta mobile

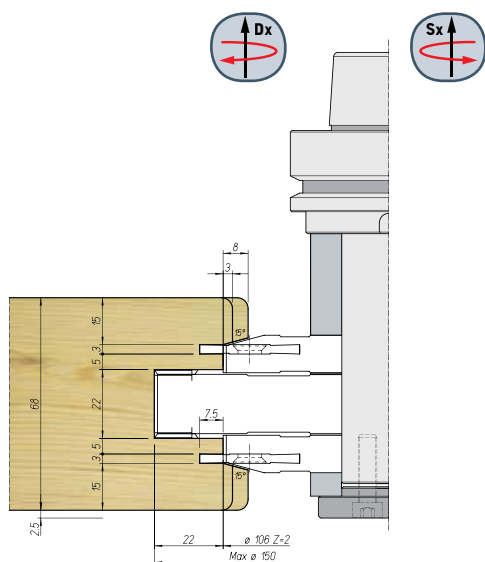

Codice

AS.03D

AS.03S

Ripresa trasverso inferiore

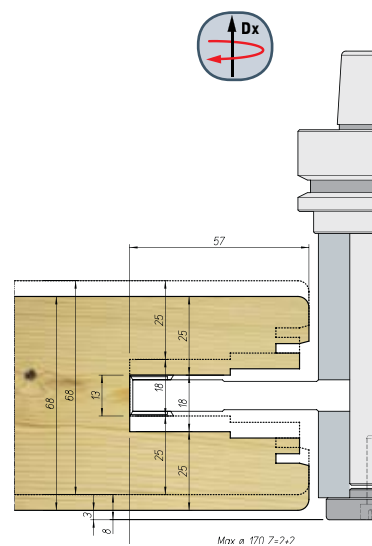

Codice

AS.04

Versione Completa

Profilatura dritta

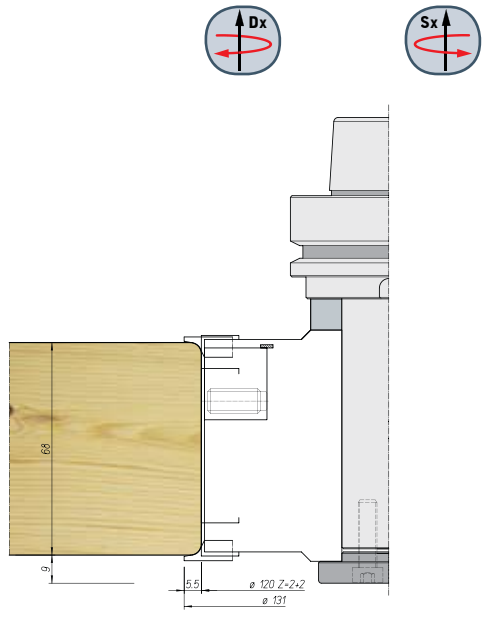

Codice
AS.01D
AS.01S

Squadratura anta fissa

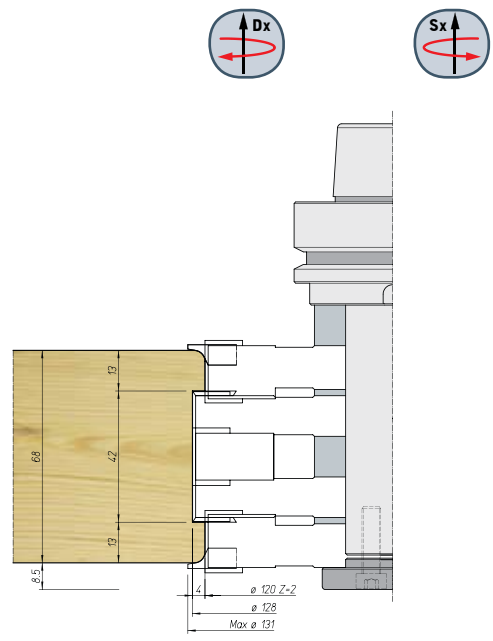

Codice
AS.05D
AS.05S

Squad. montante anta mobile

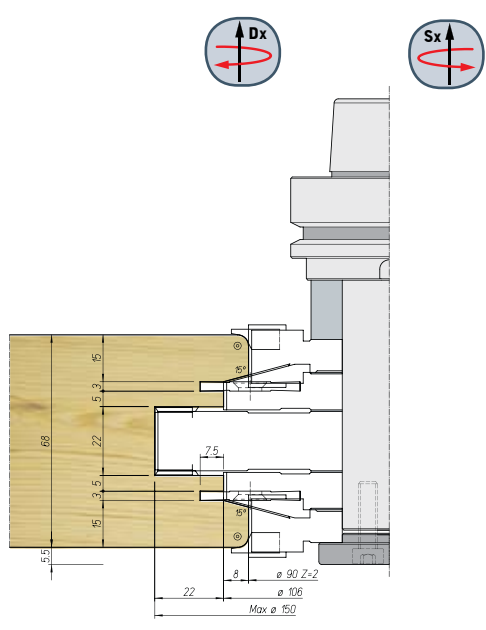

Codice
AS.06D
AS.06S

Squad. trasverso anta mobile

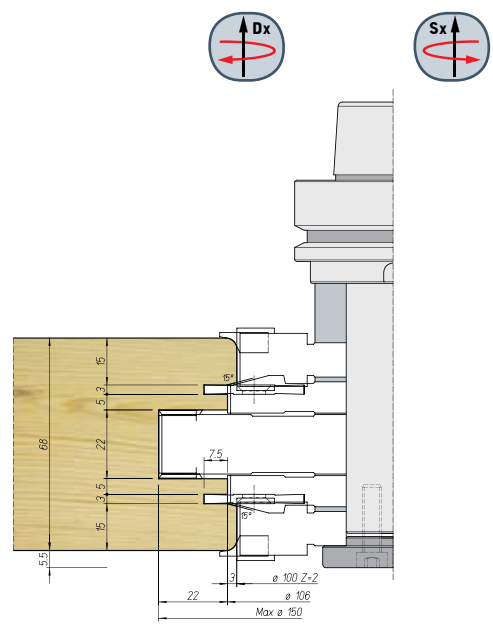

Codice
AS.07D
AS.07S

Attenzione:
forniti senza portautensile

Versione Completa

Ripresa trasverso inferiore

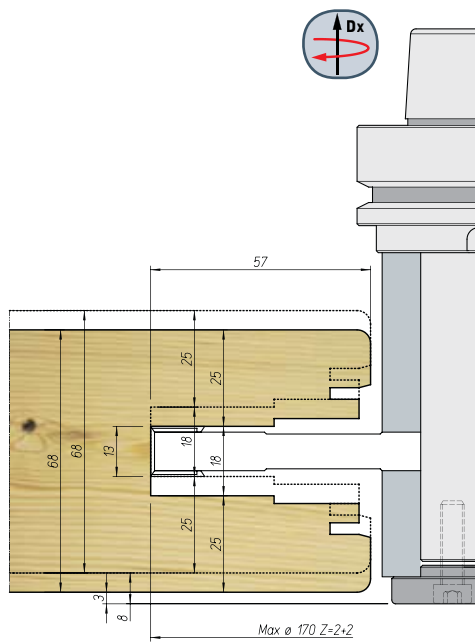

Codice
AS.04

Profilatura telaio

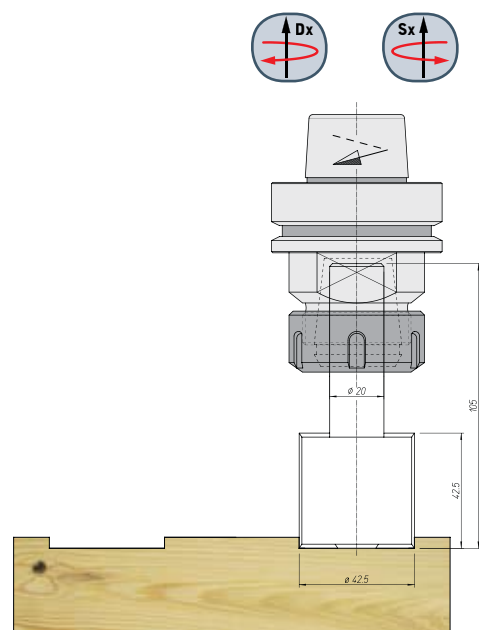

Codice
AS.02D
AS.02S